

TECHNICAL INFORMATION

CITIZEN QUARTZ

Cal. No. D04※

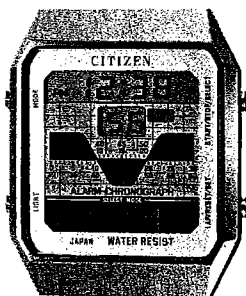

[CAL. NO. D040]

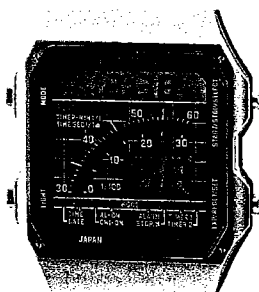

[CAL. NO. D041]



[CAL. NO. D046]

1. OUTLINE

Cal. No. D04* is available in two types; the color graphic type and the sports type. The former is designed to provide the novelty and express its functions in the dynamic color graphic display. The latter is a men's digital watch with multiple functions.

2. SPECIFICATIONS

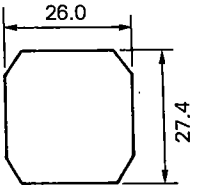
Cal. No.	Color graphic type		Sports type		
	D040	D041	D046	DA47	
Type	Digital quartz watch				
Module					
Module size (mm)					26.0 x 27.4 x 4.9t
Accuracy	±20 sec./month at normal temperatures				
Oscillation	32,768Hz				
Display functions	FE type nematic LC (Liquid Crystal) display Two-split multiplex drive				
Integrated circuit	C/MOS-LSI (1 unit)				
Effective temp. range	0°C ~ 55°C (32°F ~ 131°F)				
Adjustment of time rate	By trimmer condenser				
Measurement of time rate	2-second range				
Display method	Normal display	Hour, minute, second	←	←	←
		1/1 sec. color graphic	←	1/2, 1/1, 5/1 sec. graphic	←
	Calendar	Month, date, day	←	←	←
	Alarm	Hour, minute, AM/PM	←	←	←
	Stopwatch	Minute, second 1/100 sec. (Counting up to 60 minutes) Lap (Display accuracy within 1/10 sec.)	←	←	←
		1/1 sec. color graphic	←	1/10, 1/1, 5/1 sec. graphic	←
	Time (I) (II)	Minute, second color graphic (Counting up to 60 minutes)	←	Minute, second graphic (Counting up to 60 minutes)	←
Additional functions	Hourly chime Alarm monitor Instantaneous return function of timer Illumination lamp Fully automatic calendar (February ends on the 28th)				
Power cell	Parts No.	280-204			
	Cell code	CR2016			
	Size	20.0 x 1.6t (mm)			
	Voltage	3V			
	Capacity	65mAH			
	Lifetime	Approx. 3 years (on the condition that the illumination lamp, alarm, chime and timer I/II are used 3 sec./day, 20 sec./day, 24 times/day and once/day, respectively.)			
Value of current	2.2μA				

3. HANDLING INSTRUCTIONS FOR THE RESPECTIVE CAL. NOS.

(1) Nomenclature

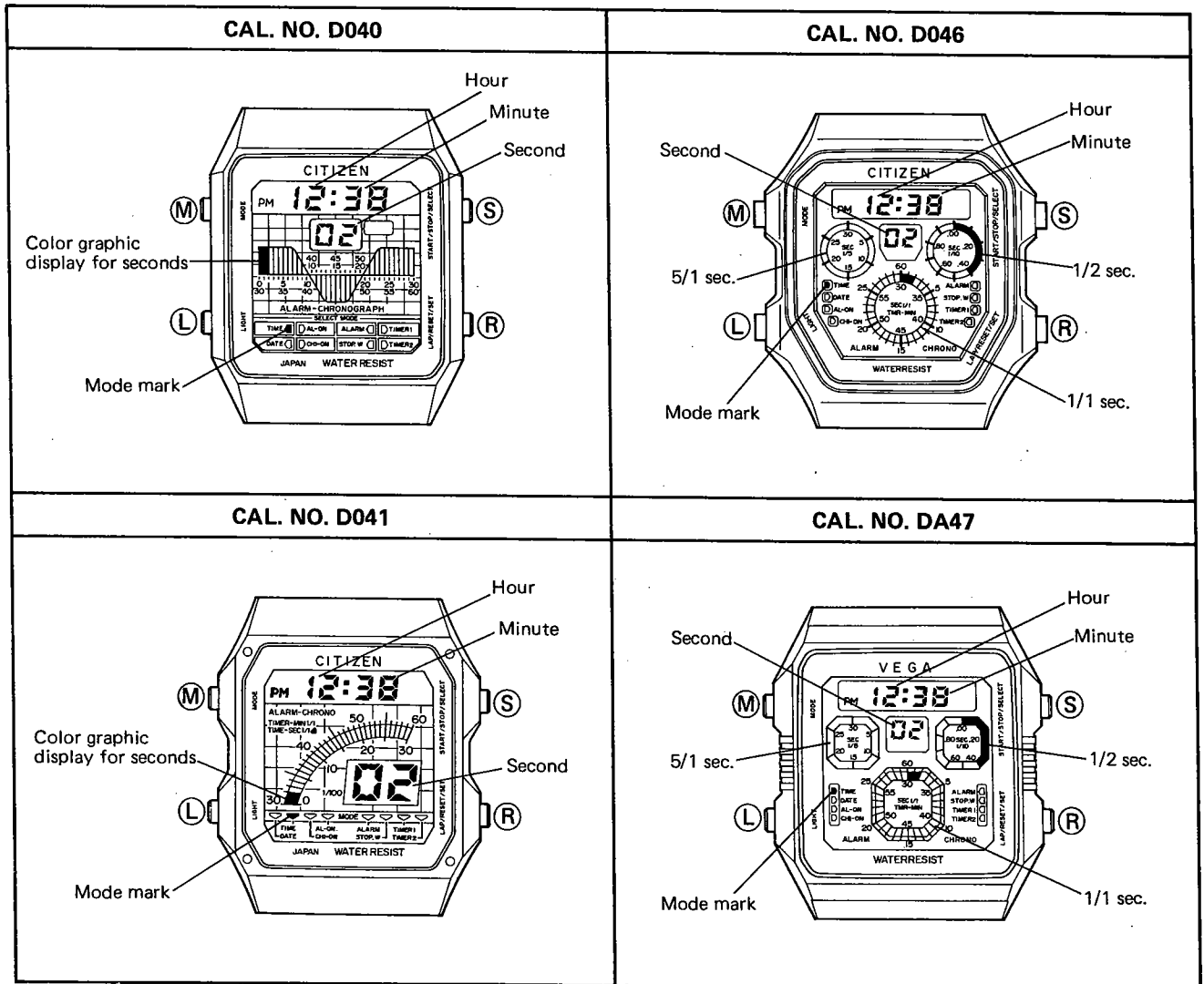

(2) Specifications of the switches

	Time		Alarm		Stopwatch	Timer (I)		Timer (II)	
	Normal	Correction	Normal	Correction		While being set	Except while being set Stopwatch	While being set	Except while being set
R button	Displaying calendar	Correction	Turning alarm and chime ON or OFF	Correction	Lap Reset	Changing over to set time	Instantaneous return	Correcting set time	Instantaneous return
S button	Summoning correction mode	Selecting digits to be corrected	Summoning correction mode	Selecting digits to be corrected	Start Stop	Start Stop		Start Stop	
M button	Changing over to mode	Restoring previous mode	Changing over to stopwatch mode	Restoring previous mode	Changing over to Timer (I)	Changing over to Timer (II)		Changing over to time mode	
L button	Illumination lamp		←		←	←		←	
R x S x M x L	Lighting up all displays, All resetting, Checking sound		←		←	←		←	

(3) Changing modes in the respective Cal. Nos.

Modes can be changed with every push of the (M) button (Mode change button) in the normal time mode, in order of alarm mode, stopwatch mode, timer (I) mode and timer (II) mode. The normal time mode is replaced by calendar mode only when the (R) button (Read set button) is pushed.

When each mode becomes available, the corresponding mode mark will light up.

3-1) Cal. No. D040

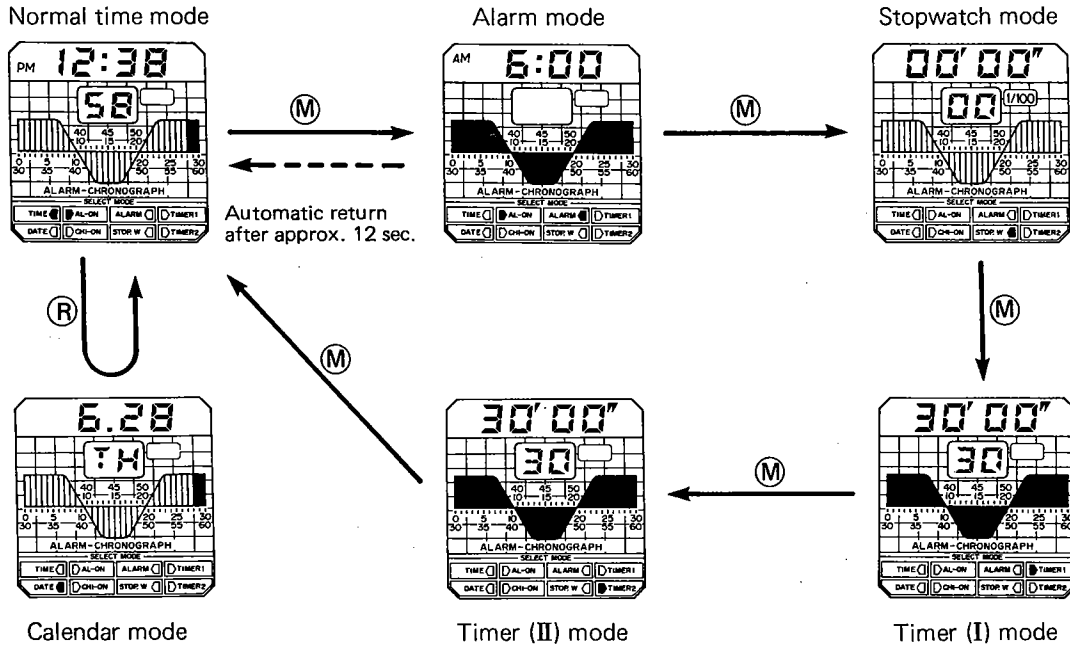

3-2) Cal. No. D041

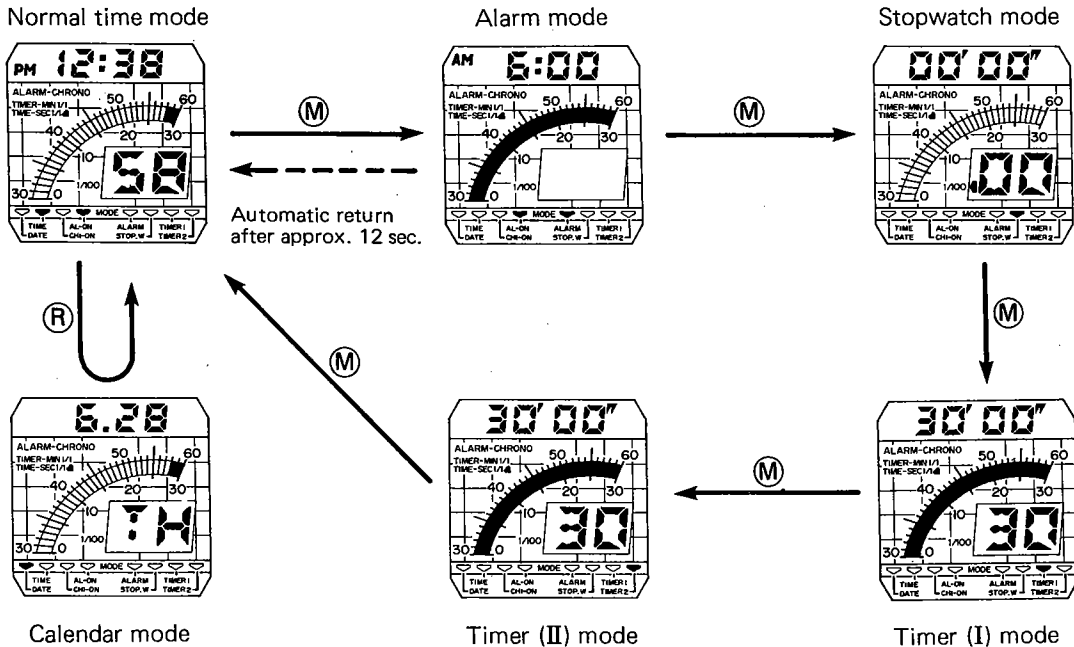

3-3) Cal. No. D046

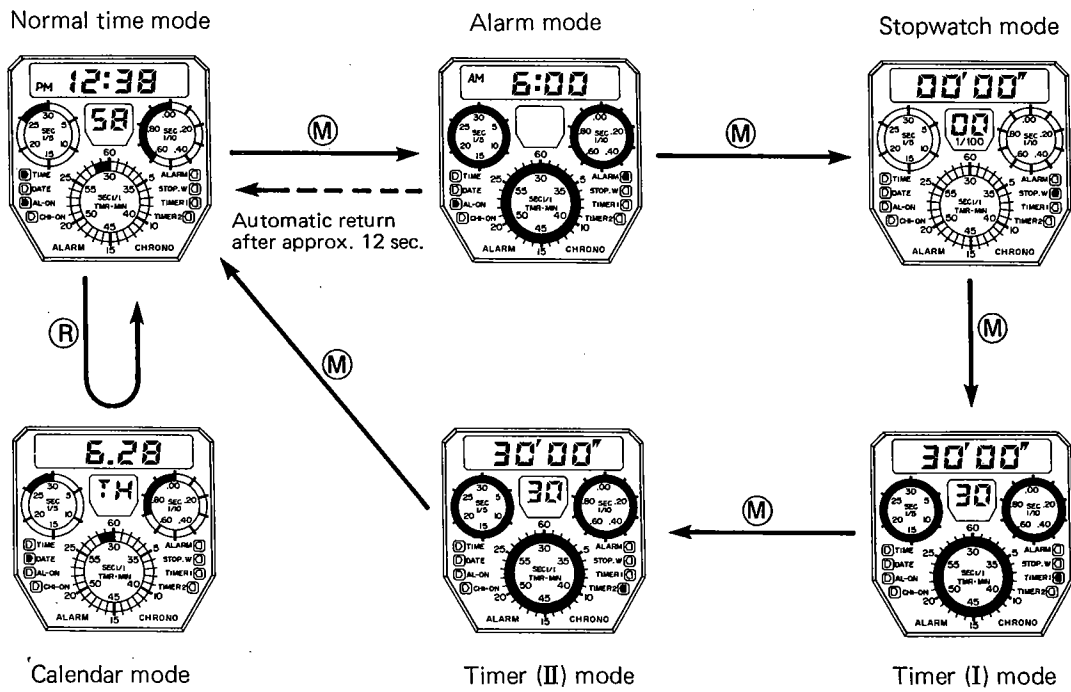

3-4) Cal. No. DA47

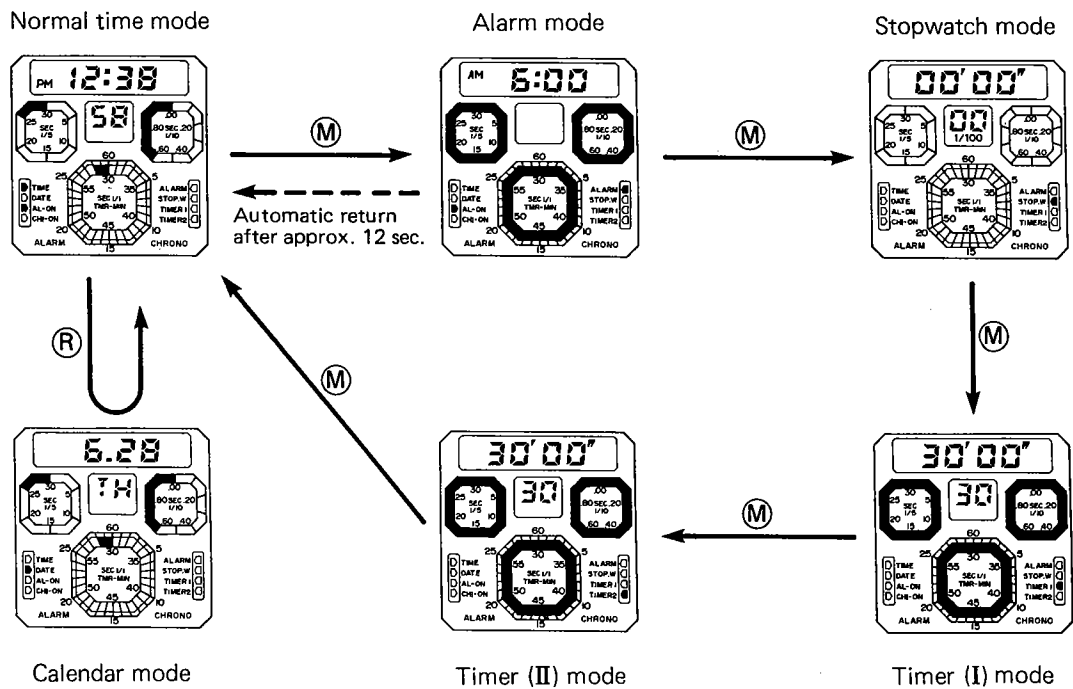

(4) Correction of time and calendar as well as change over between 12H and 24H displays in the respective Cal. Nos.

The correction procedure described below is common to all four Cal. Nos. (D040, D041, D046 and DA47).

- 1) The correction mode is obtained with a continuous push of the (S) button for more than 1 second in the normal time mode.
- 2) The items which you want to correct can be displayed with each push of the (S) button. Correct them by pushing the (R) button.

- Note 1) • The items under correction are flashing.
 • Quick correction is possible with a continuous push of the (R) button in the correction mode.
 • If the second display showing figures between 30 and 59 is reset to zero, the minute display will increase by one minute.

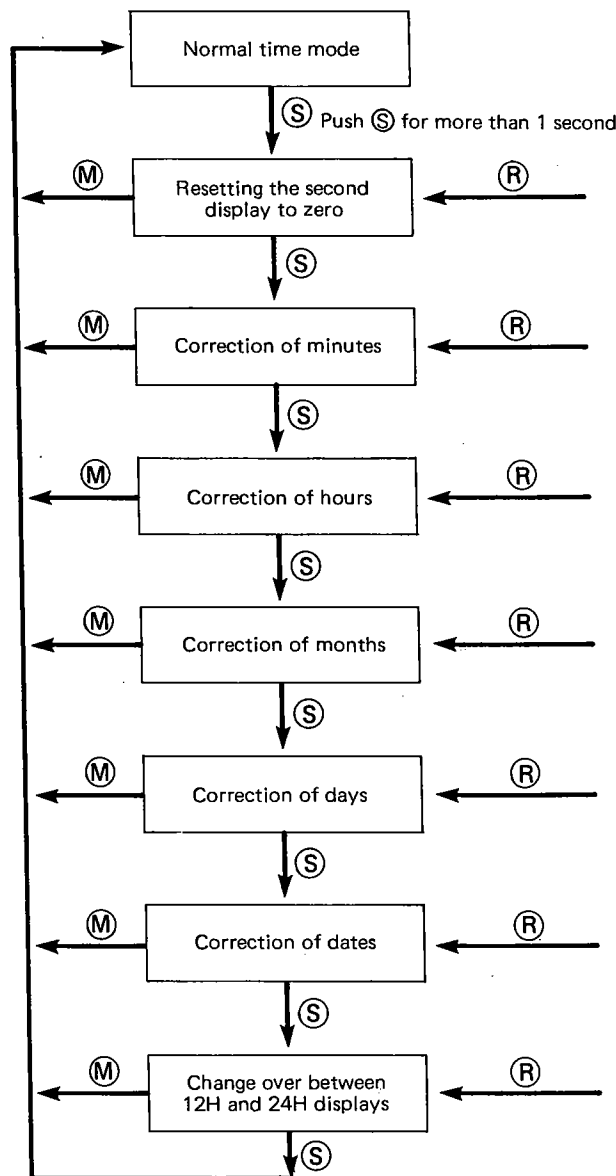

- Note 2) • If the normal time mode replaces the calendar mode in which the non-existing date has been set, the first day of the following month will be on display.
 • February 29th should be set during the leap year.

(5) Correction of alarm time

The correction procedure described below is common to all four Cal. Nos. (D040, D041, D046 and DA47).

- 1) The correction mode is obtained with a continuous push of the (S) button in the alarm mode.
- 2) The item (hour or minute) which you want to correct can be displayed with a push of the (S) button. Correct hour or minutes by pushing the (R) button.

Note 1) Quick correction is possible with a continuous push of the (R) button in the corresponding correction mode.

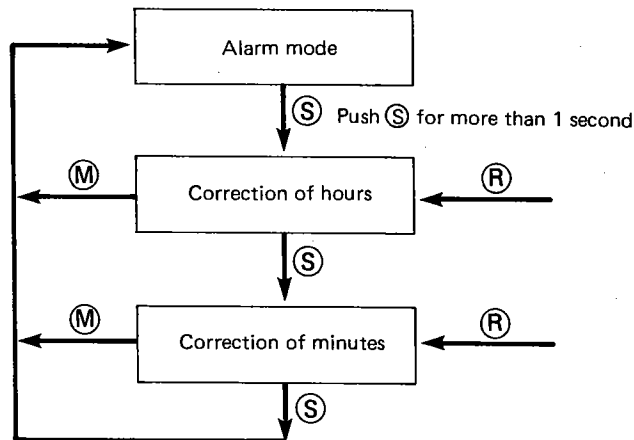

- Note 2) ● Alarm time and the 12H/24H display are interlocked with each other.
 ● Alarm sounds for approx. 20 seconds and it stops sounding by pushing any of the buttons.

(6) Turning alarm and chime ON or OFF

The correction procedure described below is common to all four Cal. Nos. (D040, D041, D046 and DA47).

- 1) If the (R) button is pushed in the alarm mode, alarm and chime will be turned on or off as follows;

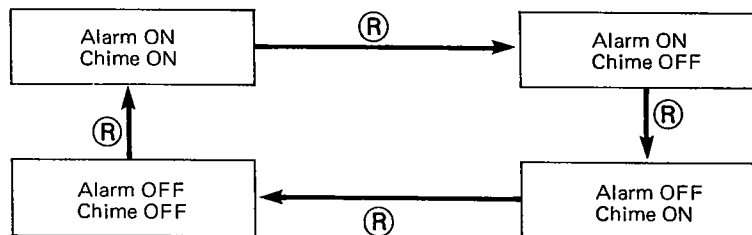

In addition, the alarm monitor starts operation with a continuous push of the (R) button.

- 2) Whether alarm and chime are turned on or off is learned from the mode mark and the second graphic display.

Note) ● If alarm or chime is turned on, the mode mark will light up, and if turned off, it will cease to light.
 ● In the alarm mode, whether the alarm is on or off can be known by whether the whole second graphic display is lit up or not.

Cal. No.	The condition of the second graphic display when alarm is on.	The condition of the second graphic display when alarm is off.
D040	The whole display lights up.	The whole display is not illuminated.
D041	The whole display lights up.	The whole display is not illuminated.
D046	1/1, 5/1 and 1/10 sec. displays light up entirely.	1/1, 5/1 and 1/10 sec. displays are not entirely illuminated.
DA47	↑	↑

(7) Operation procedure of the stopwatch

The operation procedure of the stopwatch, which is described below, is common to all four Cal. Nos. (D040, D041, D046 and DA47).

1) The stopwatch operation can be proceeded by pushing the (S) and (R) buttons in the stopwatch mode.

- Note)
- The stopwatch can count up to 60 minutes. If it counts up to 59 minutes 59 seconds 99, it immediately starts counting from 00 minute 00 second 00, thus enabling continuous counting.
 - During the lap running, the second graphic display is also running.
 - A confirmation sound is heard if the stopwatch is operated to start or stop.
 - When the stopwatch is in the condition of lap running or lap stop, lap will be cancelled by changing the mode with a push of the (M) button.

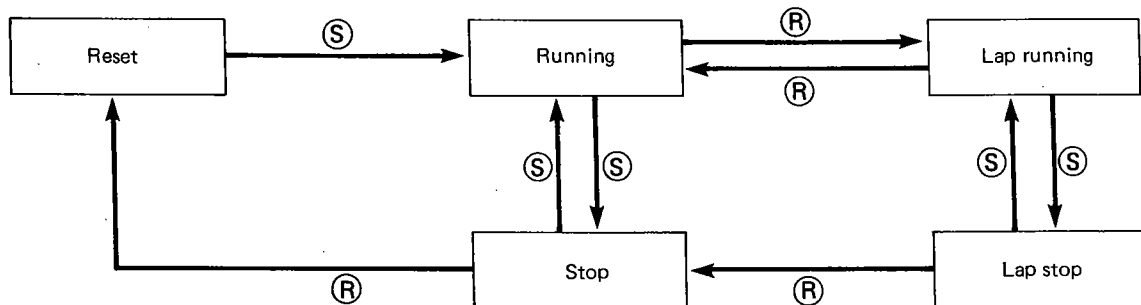

(8) Operation procedure of the timers

The operation procedure of the timers, which is described below, is common to all four Cal. Nos. (D040, D041, D046 and DA47).

<Operation procedure of the timer (I)>

1. If the minute display on the timer is equal to the figures which you want to set, in the timer (I) mode, the minute display will flash on and off.
2. If pushing the (R) button at this time, minutes can be set to figures between 5 and 60 with an interval of 5 minutes.

Note) Quick correction is possible with a continuous push of the (R) button for more than 1 second.

3. Operation of the timer (I) is available by pushing the (S) and (R) buttons.

- Note)
- A confirmation sound is heard when the timer is operated to start or stop with a push of the (S) button or when the timer is operated to instantaneously return with a push of the (R) button.
 - A warning sound is heard for each period which follows until the time is over; 10 min., 5 min., 1 min., 30 sec., 20 sec., 10 sec., 5 sec., 4 sec., 3 sec., 2 sec., and 1 sec.
 - If the time is over, the alarm will sound for approx. 2 seconds.

- After the time is over, the timer automatically serves as a stopwatch and counts from 00 min. 00 sec. 00.
- If the Ⓡ button is pushed while the timer is running, the timer will return to the previously set time and then start running again.
- Alarm stops sounding by pushing any of the buttons, and then returns to the previously set time.

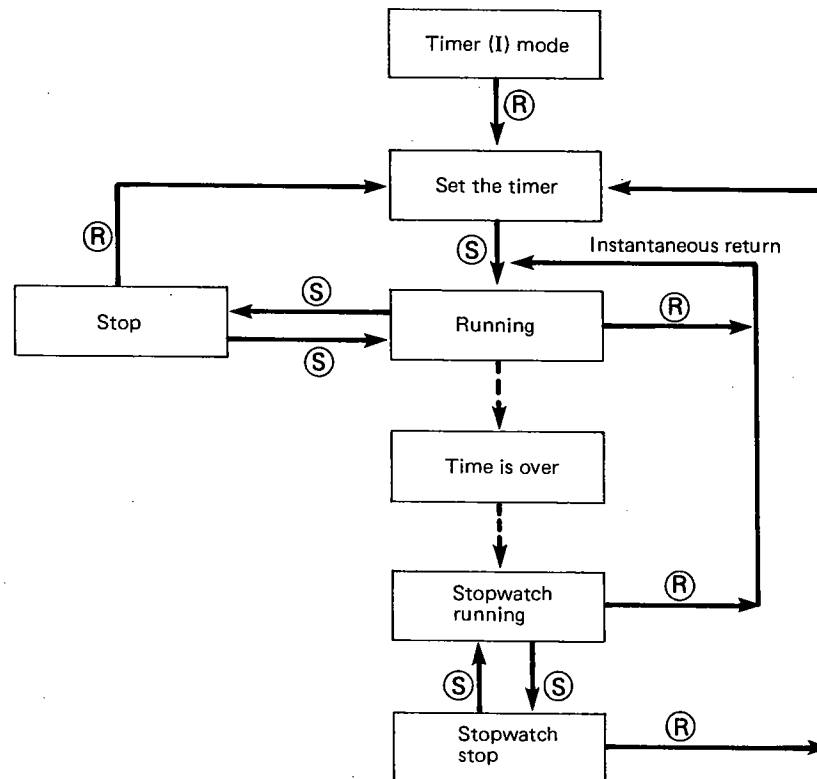

<Operation procedure of the timer (II)>

1. If the minutes display on the timer is equal to the figures which you want to set, in the timer (II) mode, the minute display will flash on and off.
2. If pushing the Ⓡ button at this time, minutes can be set between 1 and 60.
Note) Quick correction is possible with a continuous push of the Ⓡ button for more than 1 second.
3. Operation of the timer (II) is available by pushing the Ⓢ and Ⓡ buttons.
Note)
 - A confirmation sound is heard when the timer is started or stopped by pushing the Ⓢ button or when the timer is instantaneously returned by pushing the Ⓡ button.
 - If the time is over, the alarm will sound for approx. 10 seconds.
 - After the time is over, the timer automatically returns to the previously set time.
 - If the Ⓡ button is pushed while the timer is running, the timer will return to the previously set time and then start operation again.
 - Alarm stops sounding by pushing any of the buttons.

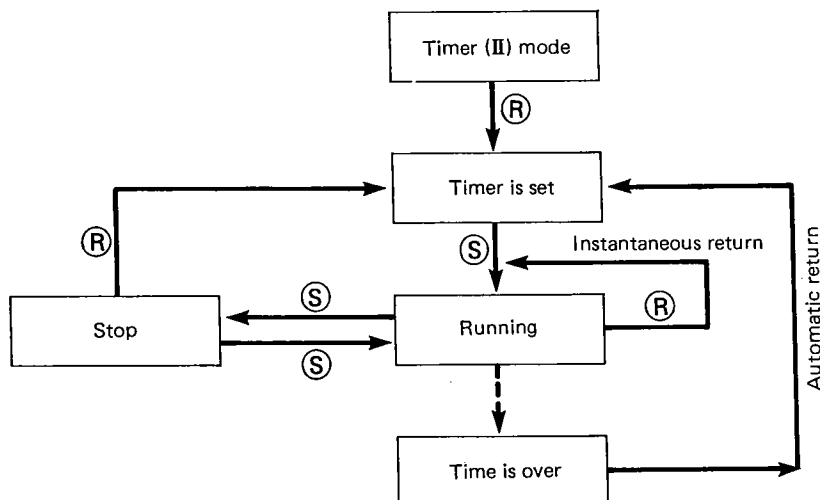

(9) Graphic display of the respective Cal. Nos.

1) Graphic display of Cal. No. D040

<Time mode>

Between 0 and 30 seconds, the graphic display increases its lighting area on a one second basis. On the contrary, it decreases its lighting area on a one second basis between 31 and 60 seconds.

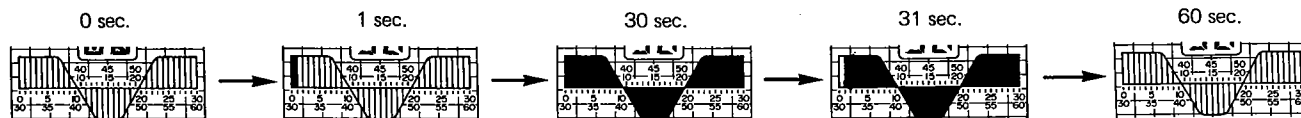

<Stopwatch mode>

1. The graphic display ceases to light entirely if the stopwatch is reset. After the stopwatch starts running, the graphic display is available in the same manner as in the time mode.
2. If the stopwatch stops running, the graphic display will keep the same lighting area as before, but it increases or decreases its lighting area while the stopwatch is lap running.

<Timer mode>

1. If the timer is set, the following displays will be obtained depending on set time.

Set time	Display	Set time	Display
60 min.		55 min.	
50 min.		45 min.	
40 min.		35 min.	
30 min.		25 min.	

20 min.		15 min.	
10 min.		5 min.	

2. While the timer is running, the graphic display increases its lighting area on a one minute basis between 60 and 30 minutes, and it decreases its lighting area on a one minute basis between 30 and 1. Then afterwards, the graphic display increases its lighting area on a one second basis between 60 and 30 seconds and it decreases its lighting area on a one second basis between 30 and 1.

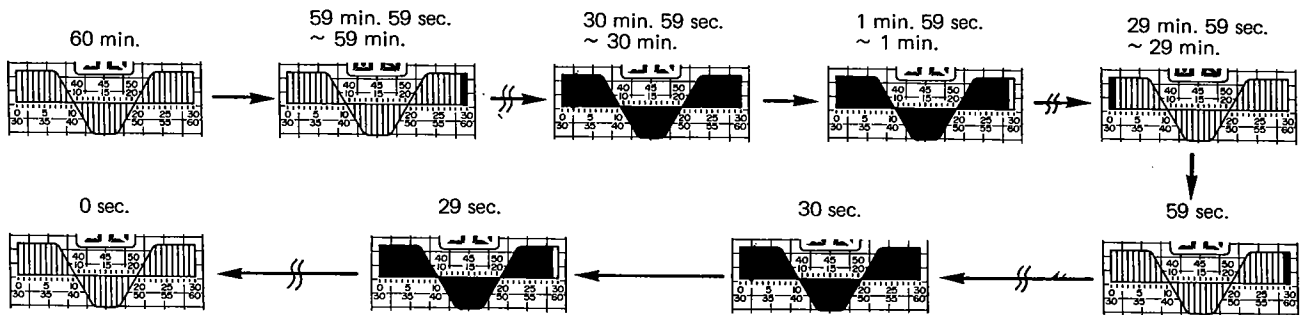

3. If the timer stops running, the graphic display will remain as it is.

<Timer (II) mode>

1. If the timer is set, the graphic display will increase its lighting area on a one minute basis between 60 and 30 minutes, and it decreases its lighting area on a one minute basis between 30 and 1.

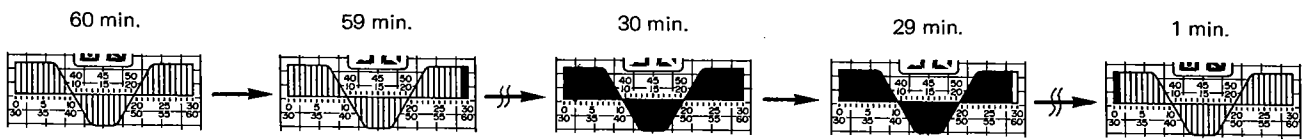

2. When the timer is running or when the timer stops, the graphic display is available in the same manner as in the preceding item, <Timer (I) mode>.

2) Graphic display of Cal. No. D041

<Time mode>

The graphic display increases its lighting area on a one second basis between 0 and 30 seconds, and it decreases its lighting area on a one second basis between 31 and 60 seconds.

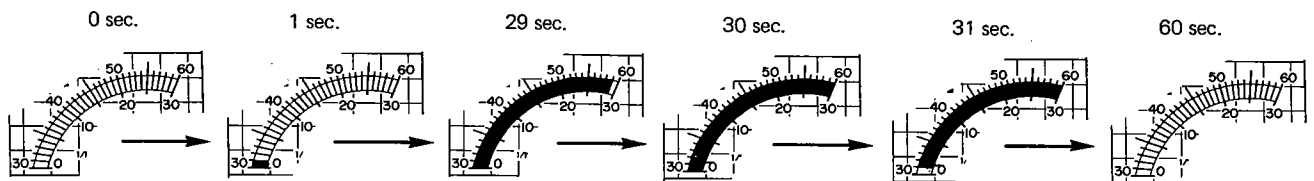

<Stopwatch mode>

1. The graphic display ceases to light entirely if the stopwatch is reset. After the stopwatch starts running, the graphic display is available in the same manner as in the time mode.
2. If the stopwatch stops running, the graphic display will keep the same lighting area as before, but it increases or decreases its lighting area when the stopwatch is lap running.

<Timer mode>

1. If the timer is set, the following displays will be obtained depending on set time.

Set time	Display	Set time	Display	Set time	Display
60 min.		55 min.		50 min.	
45 min.		40 min.		35 min.	
30 min.		25 min.		20 min.	
15 min.		10 min.		5 min.	

2. When the timer is running, the graphic display increases its lighting area on a one minute basis between 60 and 30 minutes, and it decreases its lighting area on a one minute basis between 30 and 1. Then afterwards, the graphic display increases its lighting area on a one second basis between 60 and 30 seconds, and it decreases its lighting area on a one second basis between 30 and 0.

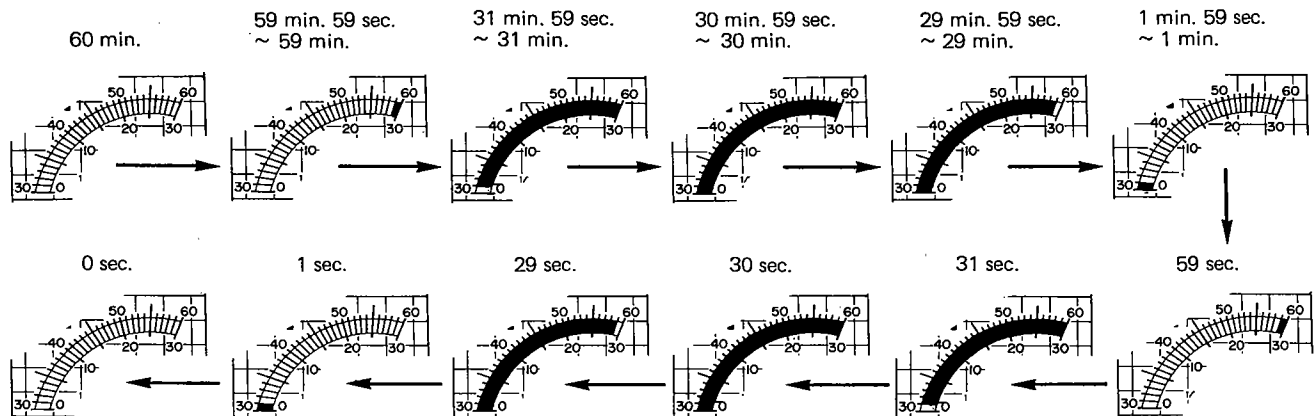

3. If the timer stops, the graphic display will remain as it is.

<Timer (II) mode>

1. If the timer is set, the graphic display increases its lighting area on a one minute basis between 60 and 30 minutes, and it decreases its lighting area on a one minute basis between 30 and 1.

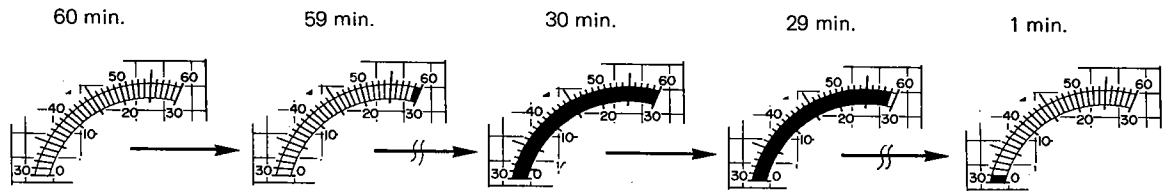

2. When the timer is running or when the timer stops, the graphic display is available in the same manner as in the preceding item, <Timer (I) mode>.
- 3) Cal. Nos. D046 and DA47

<Time mode>

1. 1/10 sec. display

The graphic display increases its lighting area on a 0.5 second basis between 0 and 5 seconds, 10 and 15 seconds, 20 and 25 seconds, 30 and 35 seconds, 40 and 45 seconds, and between 50 and 55 seconds. On the contrary, it decreases its lighting area on a 0.5 second basis between 5 and 15 seconds, 15 and 20 seconds, 25 and 30 seconds, 35 and 40 seconds, 45 and 50 seconds, and between 55 and 60 seconds.

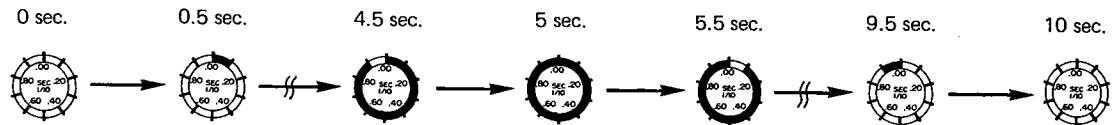

2. 1/1 sec. display

The graphic display increases its lighting area on a one second basis between 0 and 30 seconds, and it decreases its lighting area on a one second basis between 31 and 60 seconds.

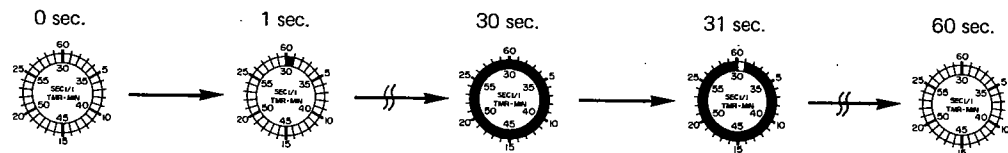

3. 5/1 sec. display

The graphic display increases its lighting area on a five-second basis between 0 and 30 seconds, and it decreases its lighting area on a five-second basis between 31 and 60 seconds.

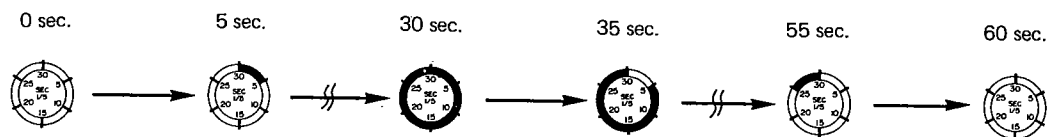

<Stopwatch mode>

1. 1/10 sec. display

If the stopwatch is reset, the graphic display will cease to light entirely. After the stopwatch starts running, the graphic display increases its lighting area on a 1/10 second basis with an interval of one second.

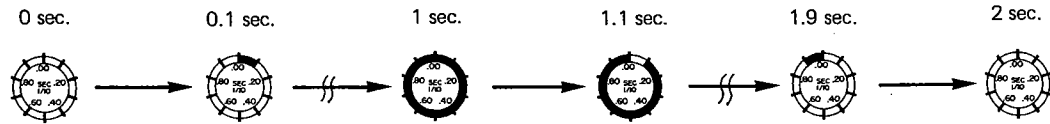

2. 1/1 sec. display

If the stopwatch is reset, the graphic display will cease to light entirely. After the stopwatch starts running, the graphic display is available in the same manner as in the time mode.

3. 5/1 sec. display

If the stopwatch is reset, the graphic display will cease to light entirely. After the stopwatch starts running, the graphic display is available in the same manner as in the time mode.

Note) In the respective displays described above, if the stopwatch stops, the graphic display will keep the same lighting area as before, but it increases or decreases its lighting area when the stopwatch is lap running.

<Timer (I) mode>

1. The graphic display when the timer is set.

a. 1/10 sec. display

If the timer is set to more than 10 minutes, the entire graphic display will light up. If the timer is set to 5 minutes, the graphic display will light up in a space equal to 2.5 seconds' area.

60 min.



More than 10 min.



b. 1/1 sec. and 1/5 sec. display

If the timer (I) is set, the following displays will be obtained depending on set time.

Set time	1/1 sec. display	5/1 sec. display	Set time	1/1 sec. display	5/1 sec. display
60 min.			55 min.		
50 min.			45 min.		
40 min.			35 min.		

30 min.			25 min.		
20 min.			15 min.		
10 min.			5 min.		

2. The graphic display when Timer (I) is running.

a. 1/10 sec. display

When the timer is running, the graphic display lights entirely if the residual time is between 60 and 10 minutes, and it decreases its lighting area on a one minute basis if the residual time is less than 10 minutes.

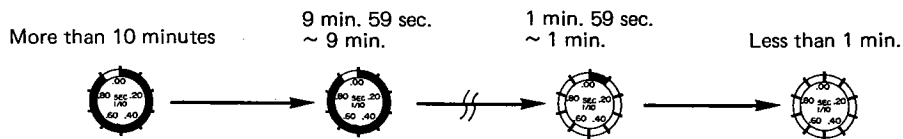

b. 1/1 sec. display

When the timer is running, the graphic display increases its lighting area on a one minute basis between 60 and 30 minutes, and it decreases its lighting area on a one minute basis between 30 and 1. Then afterwards, the graphic display increases its lighting area on a one second basis between 60 and 30 seconds, and it decreases its lighting area on a one second basis between 30 and 0.

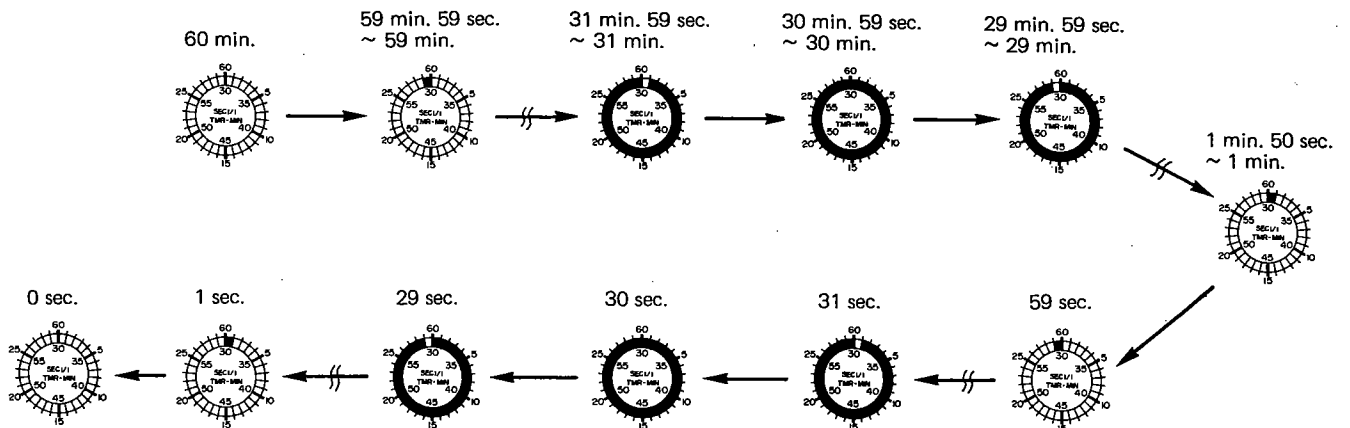

c. 5/1 sec. display

When the timer is running, the graphic display increases its lighting area on a five-minute basis between 60 and 30 minutes, and it decreases its lighting area on a five-minute basis between 30 and 1. Then afterwards, the graphic display increases its lighting area on a five-second basis between 60 and 30 seconds, and it decreases its lighting area on a five-second basis between 30 and 0.

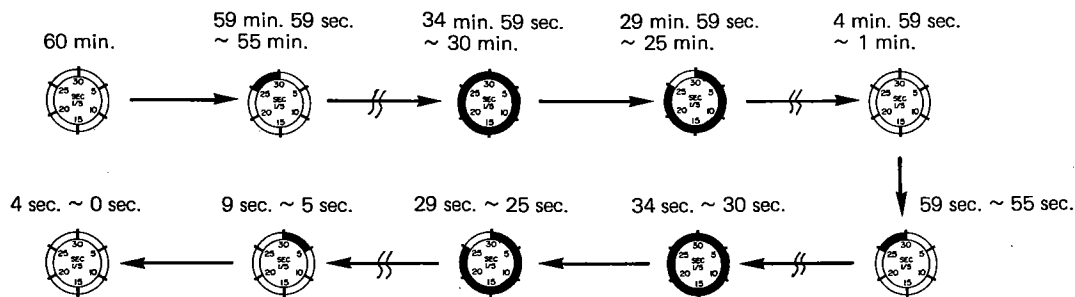

3. The graphic display when the timer (II) stops.

If the timer stops running, the graphic displays for 1/10 sec., 1/1 sec. and 5/1 sec. will remain as they are.

<Timer (II) mode>

1. The graphic display when the timer is set.

a. 1/10 sec. display

If the timer is set to more than 10 minutes, the entire graphic display will light up. If the timer is set to less than 10 minutes, the graphic display will decrease its lighting area on a one minute basis.

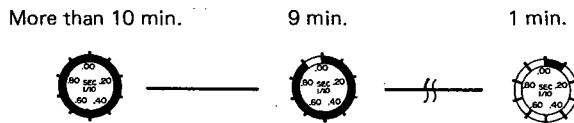

b. 1/1 sec. display

If the timer is set to figures between 60 and 30 minutes, the graphic display will increase its lighting area on a one minute basis. If the timer is set to figures between 30 and 1, the graphic display will decrease its lighting area on a one minute basis.

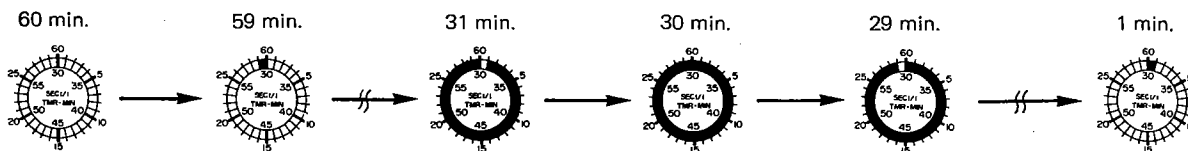

c. 5/1 sec. display

If the timer is set to figures between 60 and 30 minutes, the graphic display will increase its lighting area on a five-minute basis. If the timer is set to figures between 29 and 0, the graphic display will decrease its lighting area on a five-minute basis.

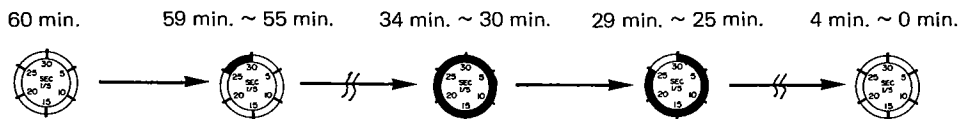

2. The graphic display when the timer is running or when the timer stops.

When the timer is running or when the timer stops, the graphic display is available in the same manner as in the preceding item, <Timer (I) mode>.

<Notes on replacing power cell>

Be sure to reset all the displays after replacing the power cell, or a non-existing date may be displayed.

1. How to reset all the displays

- ① Push the four buttons after replacing the power cell, and all the displays will light up thus resetting them.

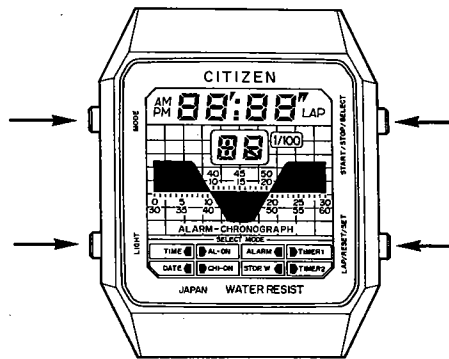

- ② If the buttons are released, an alarm will sound thus indicating that all the displays have been reset. At the same time, the normal time mode will be restored as follows;

- Normal time mode : Starts at 12 hr. 00 min. 00 sec. PM (12H display)
- Calendar mode : January 1st, Sunday
- Alarm mode : 12 hr. 00 min. PM (24H display)
- Stopwatch : 00 min. 00 sec. 00/100 sec.
- Timer I : 30 min. 00 sec.
- Timer II : 30 min. 00 sec.

■4. CONSTITUTION OF MODULE
 <Constitutional diagram of the circuit>

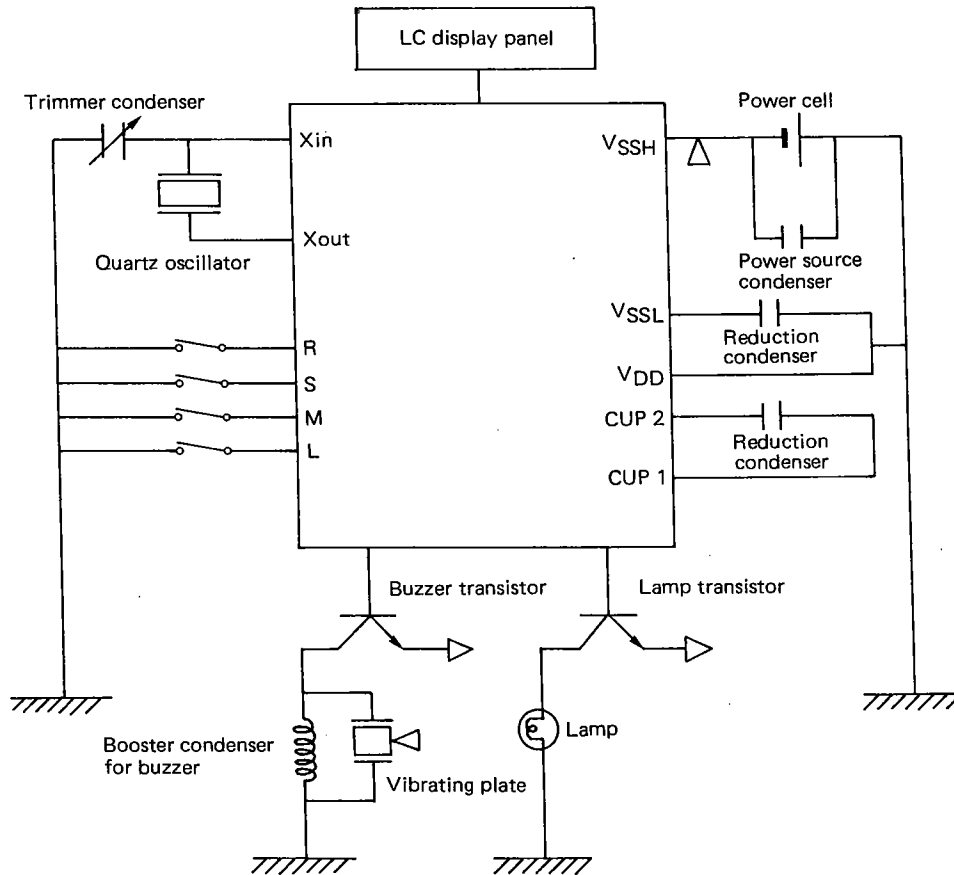

<Constitution of plate complete>

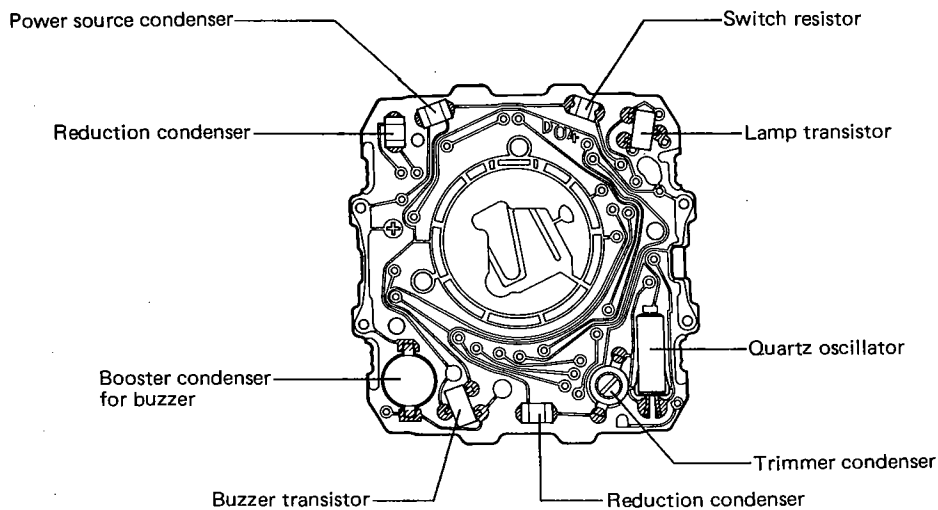

■5. NOTES ON DISASSEMBLY AND ASSEMBLY OF MODULE

(1) Notes on replacing the power cell

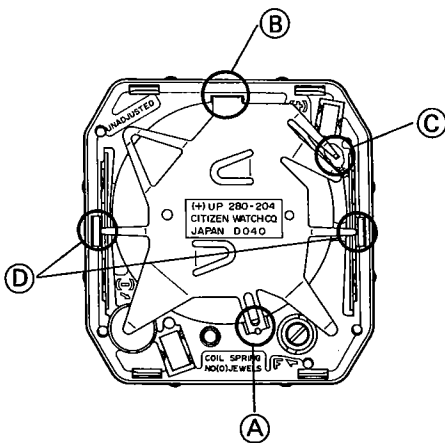

1. Removing the power cell

As illustrated to the left, the power cell is fixed to the supporter for plate complete with the power cell strap at the sections (A) and (B). Remove the power cell strap by pulling up the section (A) of the power cell strap toward the power cell, and the power cell is removed.

2. Mounting the power cell

Mount the power cell first. Fix the section B of the power cell strap to the supporter for plate complete and insert the section of the power cell strap under the supporter for plate complete. Thus, the power cell is fixed.

3. Confirmation after the power cell is mounted

Confirm that the sections (C) and (D) of the power cell strap are in a good contact with the plus pattern of the plate complete and the switch actuating spring, respectively.

(2) Handling the supporter for plate complete

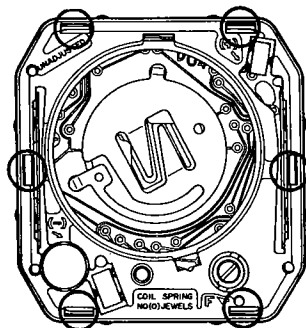

The supporter for plate complete is fixed to the LC display panel supporter with 6 hooks. Loosen the hooks circled in the illustration to the left by using a pair of tweezers and remove the supporter for plate complete.

If the supporter for plate complete is pushed in from the power cell side, it automatically fixes to the LC display panel supporter with the 6 hooks. Thus, mounting the supporter for plate complete is finished. After mounting, confirm that the supporter for plate complete is properly fixed with the hooks.

(3) Direction of the LC display panel and the plate complete

LC display panel

Plate complete

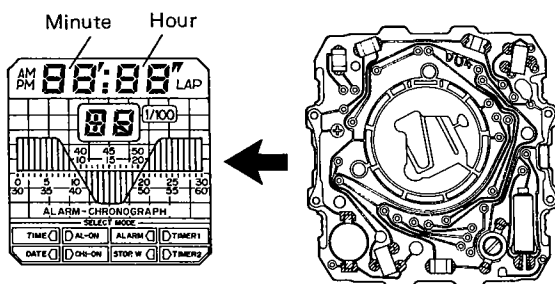

Both the LC display panel supporter and the light diffusing plate are free from direction, and thus the LC display panel is not bound to direction. In other words, the LC display panel, light diffusing plate and the LC display panel connection rubber may be mounted to the LC display panel supporter at random.

After the above procedure is finished, the plate complete is mounted. It allows the smooth mounting even if it is placed upside down. However, a bad mounting will cause a poor display. Be sure to keep the following in mind when mounting the plate complete.

As illustrated to the left, mount the LC display panel, the light diffusing plate and the LC display panel connection rubber to the LC display panel supporter in such a way that the hour and minute displays on the LC display panel will be on the topside.

Then, mount the plate complete so that the quartz oscillator will be on the lower right.

6. DISASSEMBLY AND ASSEMBLY OF MODULE

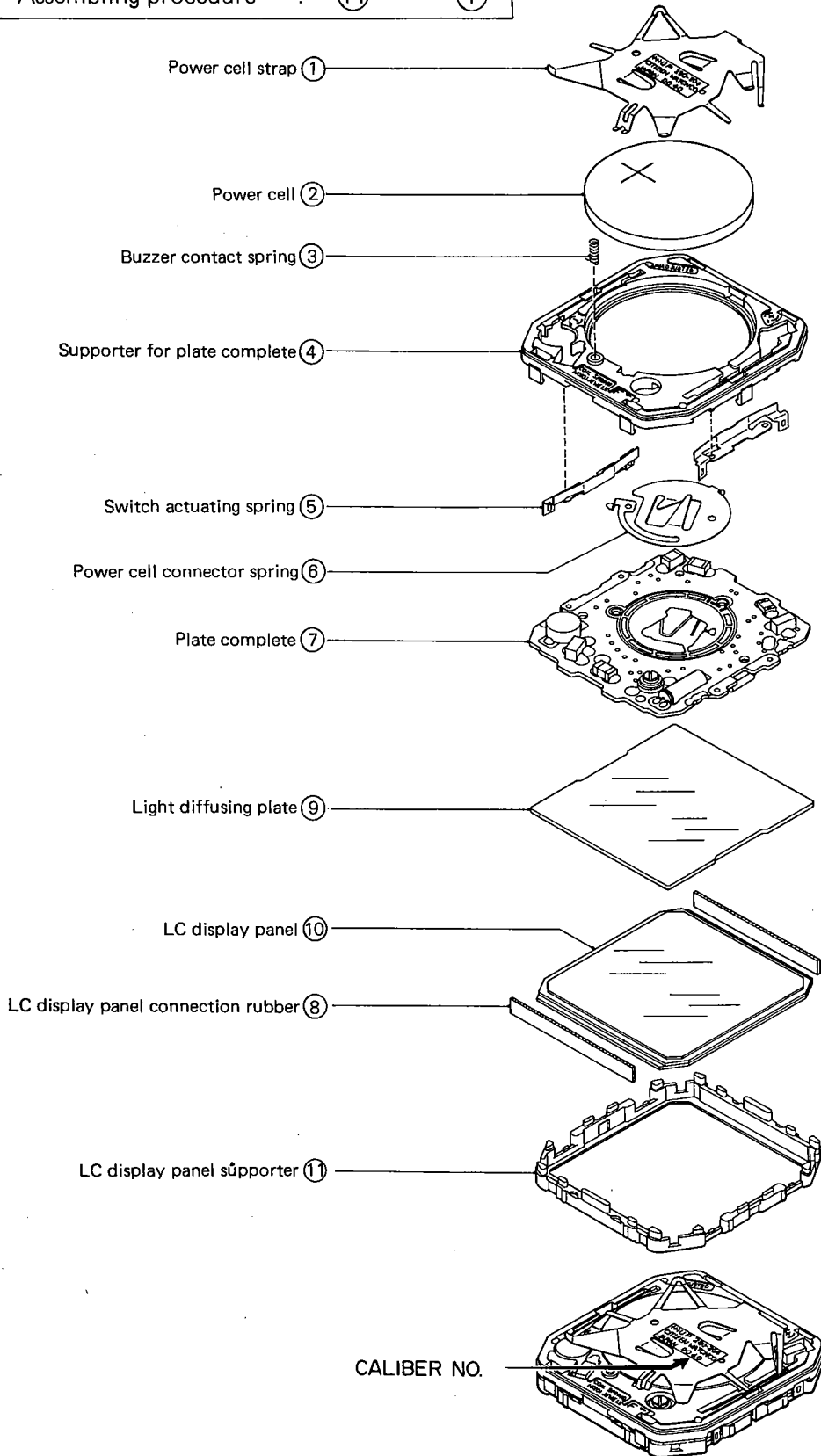

Disassembling procedure : ① → ⑪

Assembling procedure : ⑪ → ①

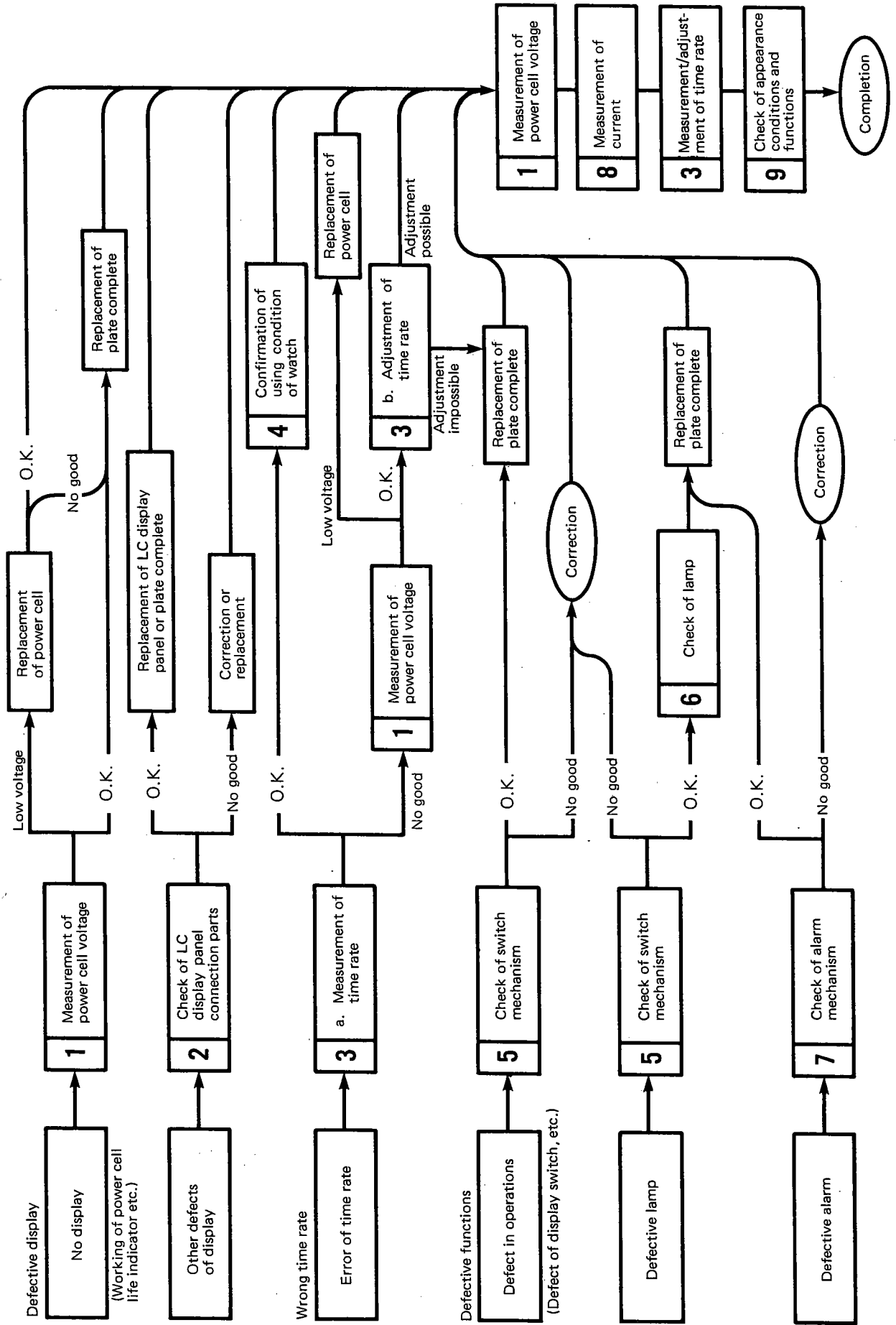

7. TROUBLESHOOTING AND ADJUSTMENT

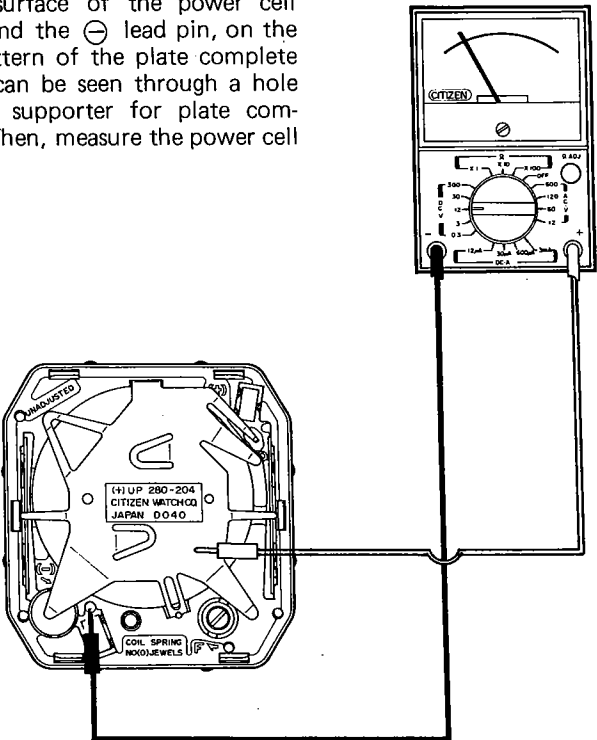

Check points	How to check	Results & treatment
<p>1 Checking power cell voltage</p>	<p>As shown in the illustration, put the ⊕ lead pin of the tester on the upper surface of the power cell strap, and the ⊖ lead pin, on the ⊖ pattern of the plate complete which can be seen through a hole on the supporter for plate complete. Then, measure the power cell voltage.</p> <p style="text-align: center;"><Tester range: D.C. 12V></p> 	<ul style="list-style-type: none"> ● Over 2.8V → Nondefective ● Under 2.8V → Replace the power cell
<p>2 Checking connection parts of LC display panel</p>	<p>1. Checking all the segments;</p> <p>All the displays light up with a simultaneous push of the buttons (M), (S), (M) and (L). At this moment, check all the segments to see whether they are defective or not.</p>  <p>2. Checking conductivity with the LC display panel, the LC display panel connection rubber and the plate complete;</p> <ul style="list-style-type: none"> ● Make sure that the LC display panel, the LC display panel connection rubber and the plate complete have been properly mounted. ● Check that there is no dust, dirt, cuts, cracks or scratches on each conductive part (between the pattern of the plate complete and the LC display panel connection rubber, and between the LC display panel connection rubber and the LC display panel). 	<ul style="list-style-type: none"> Bad mounting → Mount again Dust or dirt → Remove it Cuts, cracks, scratches or warp → Replace the defective part with a new one

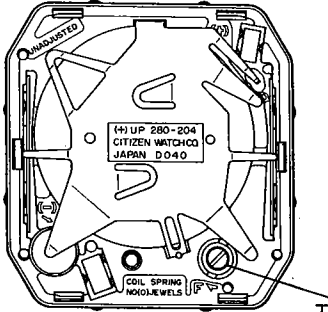
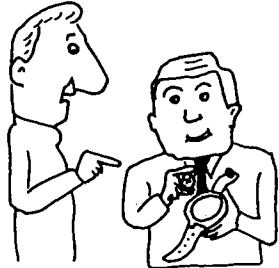
Check points	How to check	Results & treatment
<p>3 Measurement and adjustment of time rate</p>	<p>1. Measurement of time rate Measurement of time rate can be made with the "MEASURE TIME" set at a range of 2 seconds.</p> <p>2. Adjustment of time rate Make an adjustment by turning the trimmer condenser clockwise.</p>  <p style="text-align: right;">Trimmer condenser</p>	<div style="border: 1px solid black; padding: 5px;"> <p>Do not measure time rate in direct sun or incandescent light, or correct measurement may not be obtained due to a shift in the time rate.</p> </div>
<p>4 Confirming using conditions</p>	<p>Make sure in which environment the customers use their watch checking the following points;</p>  <ul style="list-style-type: none"> ● Whether they handle it properly or not ● Whether they use it beyond the effective temperature range ● How long it has been since they set the watch 	
<p>5 Checking switch mechanism</p>	<p>1. Checking the movement;</p> <ul style="list-style-type: none"> ● Push the switch actuating spring with the tweezers and bring it into contact with the pattern of the plate complete to confirm the switch function. ● Confirm that the pattern of the plate complete has not peeled off and also confirm that the switch actuating spring has not been deformed. <p>2. Checking the push buttons;</p> <ul style="list-style-type: none"> ● Check that the push buttons attached on the case have not been deformed or soiled. <p>Note) Be sure to apply silicon oil to the packing of the push buttons to maintain water-resistance and smooth operation of the buttons.</p>	<p>The switch function is available. → Check the push buttons.</p> <p>The switch function is not available. → Remove dust or dirt from each contact part.</p> <p>The pattern has peeled off. → Replace the plate complete.</p> <p>The switch actuating spring has been deformed. → Return it to its proper shape or replace it with a new one.</p>

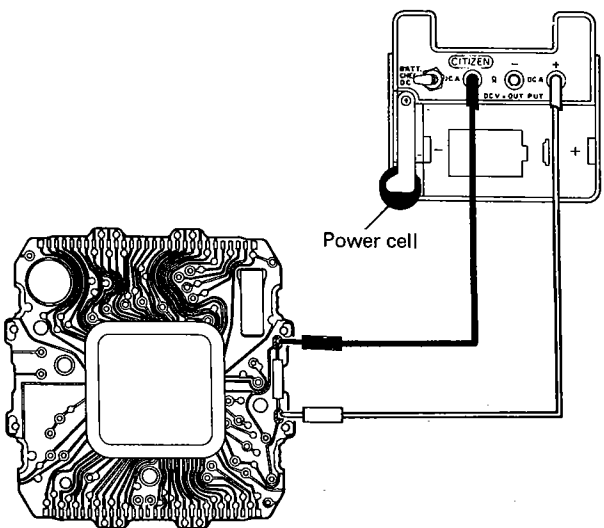
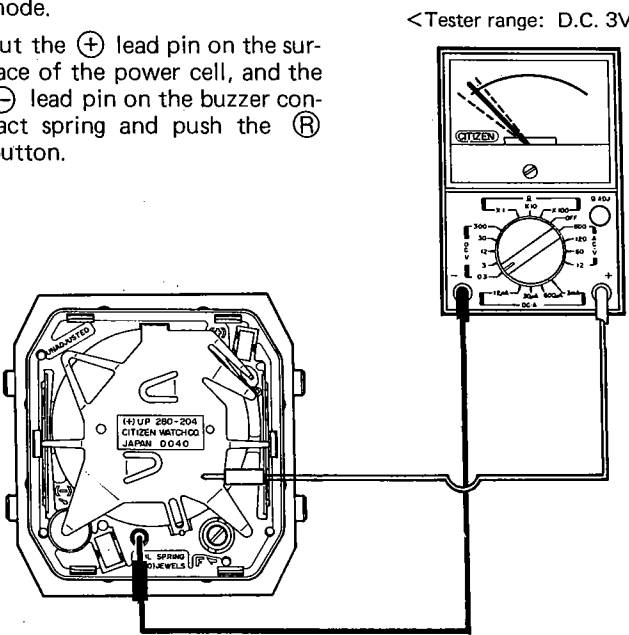
Check points	How to check	Results & treatment
<p>6 Checking illumination lamp</p>	<p>Mount the power cell on the adapter of the tester and check the lamp using D.C.V. OUT-PUT as shown in the illustration. (There is no polarity.)</p> 	<p>The lamp lights up. → Nondefective</p> <p>The lamp does not light up. → Replace the plate complete.</p>
<p>7 Checking alarm function</p>	<p>1. Confirm alarm output with the module mounted in the case and with the case back left unremoved.</p> <p>1) Set the watch to the alarm mode.</p> <p>2) Put the ⊕ lead pin on the surface of the power cell, and the ⊖ lead pin on the buzzer contact spring and push the ⊕ button.</p> <p><Tester range: D.C. 3V></p>  <p>2. When there is no problem with the alarm output, check the following points;</p> <p>1) If there are no cuts or cracks on the piezo-electric element of the vibrating plate.</p> <p>2) If the buzzer contact spring has not been bent or deformed.</p> <p>3) If there is no dust or dirt on the pattern of the unit of electronic circuit.</p>	<p>The tester pointer swings. → The unit of electronic circuit is not defective. Proceed to the item No. 2</p> <p>The tester pointer does not swing. → Replace the unit of electronic circuit.</p> <p>Cuts or cracks → Replace the case.</p> <p>The buzzer contact spring has been bent or deformed. → Replace it with a new one.</p> <p>Dust or dirt → Remove it.</p>

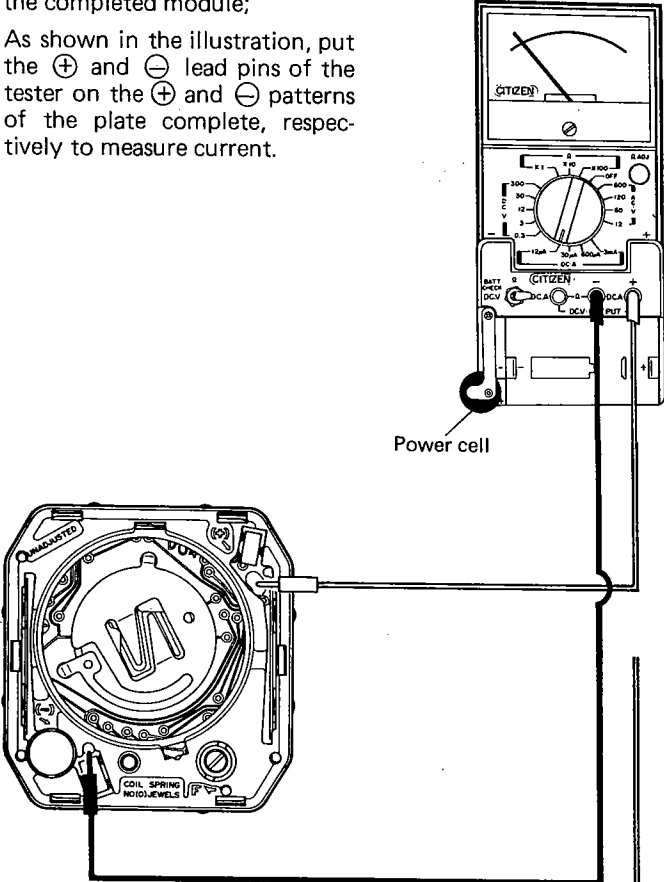
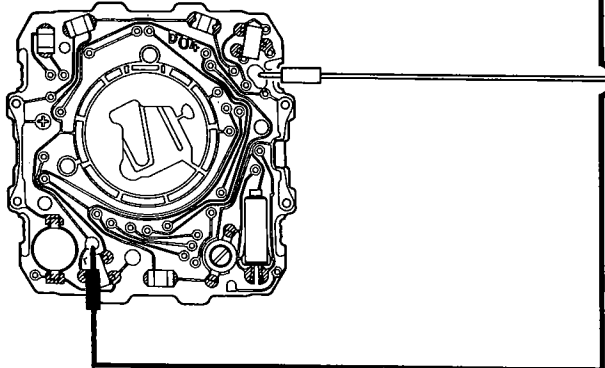
Check points	How to check	Results & treatment
<p>8 Measurement of current</p>	<p>If the power source is generated, a large amount of current will flow through this watch. Therefore, if measuring current with the tester range set at $12\mu\text{A}$, the tester pointer will swing beyond the limits.</p> <p>Make a measurement gradually increasing the tester range from 3mA to $12\mu\text{A}$.</p> <p>1. Measuring current consumed by the completed module;</p> <p>As shown in the illustration, put the \oplus and \ominus lead pins of the tester on the \oplus and \ominus patterns of the plate complete, respectively to measure current.</p> <p style="text-align: right;"><Tester range: D.C. $12\mu\text{A}$></p>  <p>2. Measuring the plate complete separately for current;</p> 	<p>Current value of the completed module</p> <ul style="list-style-type: none"> ● Under $2.2\mu\text{A}$ → Nondefective ● Over $2.2\mu\text{A}$ → Measure the plate complete separately for current. <p>Notes on measuring</p> <p>Do not measure in direct sun or incandescent light, or correct measurement may not be obtained.</p> <p>Current value of the plate complete alone</p> <ul style="list-style-type: none"> ● Under $1.8\mu\text{A}$ → The plate complete is nondefective. Mount the LC display panel from the beginning. Current value is still over $2.2\mu\text{A}$ though the LC display panel has been mounted again. → Replace either the LC display panel connection rubber or the LC display panel. ● Over $1.8\mu\text{A}$ → Replace the plate complete.

Check points	How to check	Results & treatment
<p>9 Checking appearance and functions</p>	<p>Check the following points;</p> <ol style="list-style-type: none"> Whether there is no dust or dirt inside the case Whether all the segments have been provided Check it with all the segments kept lit by simultaneously pushing the buttons, (M), (S), (M) and (L). <div data-bbox="558 491 1024 842" data-label="Image"> </div> <ol style="list-style-type: none"> Whether there is no problem with the switching functions and with each correction initiated by the operation of the push buttons. 	

CITIZEN WATCH CO., LTD.
Tokyo, Japan